

# HEWLETT-PACKARD JOURNAL

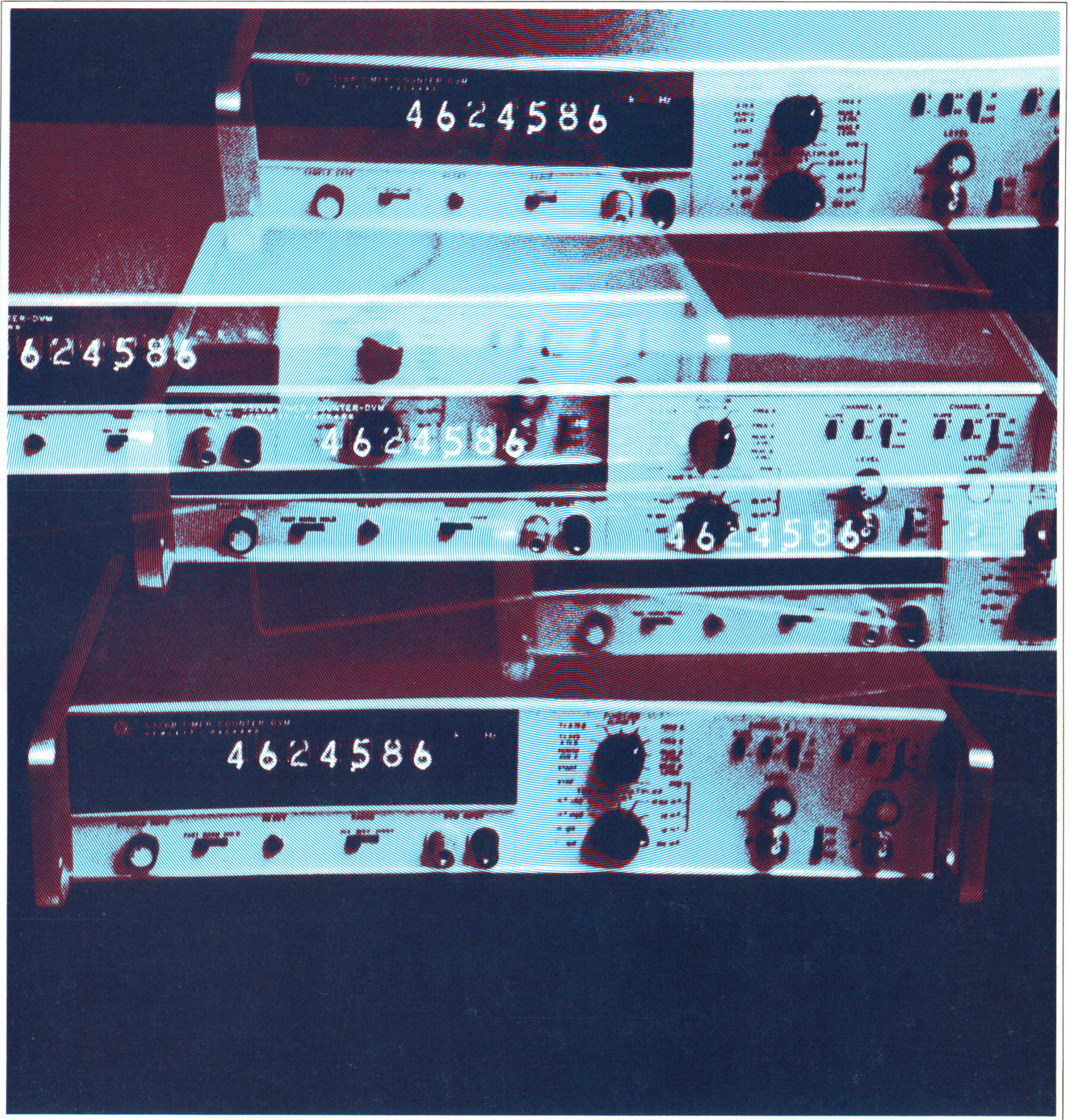

APRIL 1970

# Timer/Counter/DVM: A Synergistic Prodigy?

*One version of this medium-cost universal counter has an internal digital voltmeter, from which it derives some surprising capabilities. Both versions can average repetitive time intervals for increased resolution, and can measure the frequencies of pulsed carriers.*

**By Kenneth J. Jochim and Rolf Schmidhauser**

NEARLY EVERYONE KNOWS what counters and digital voltmeters are useful for. But when a counter and a DVM are put together in one instrument, the result turns out to be a good example of synergy — you can do much more with the combination than you could with two separate instruments. We refer to the new HP Model 5326B Timer/Counter/DVM, a combination of a 50 MHz universal counter and a four-digit integrating DVM (see Fig. 1).

Before we tell you what the combination can do, however, we must emphasize that the DVM isn't the new instrument's sole claim to fame. Besides having all the customary timer/counter functions, it has a brand new one — time-interval averaging — which gives it resolution better than 100 picoseconds and the ability to measure subnanosecond time intervals. It can also measure the frequencies of tone bursts or pulsed RF, and it has a number of other useful features, such as optional programmability, trigger lights that show when the input signals are causing the dual input channels to trigger, and an extra 50Ω frequency input.

## DVM Measures Trigger Levels

Model 5326B's DVM is not a plug-in or an accessory, it's internal. It measures dc voltages like any DVM, but that's not what's notable about its being in the same package with a counter. The synergistic effect is apparent, however, when you turn the front-panel FUNCTION switch to READ A LEVEL or READ B LEVEL. Then the DVM measures the voltage at which one of the counter's two input channels, A or B, is set to trigger. This new capability is most important when you need accurate measurements of voltage-dependent time intervals, such as 10-to-90% risetimes, pulse widths at 50% amplitude,

and so on. Channels A and B are the start and stop trigger inputs for time-interval measurements, so if you measure their trigger-level settings with DVM accuracy, you know precisely what points on the input waveforms are the beginning and end of the measured time interval. Before Model 5326B, these measurements could only be made with an oscilloscope, which is less accurate, or with a combination of relatively costly instruments.

The ability to measure trigger levels precisely isn't the only advantage in having a DVM and a counter in one instrument. The DVM has expanded capabilities as a

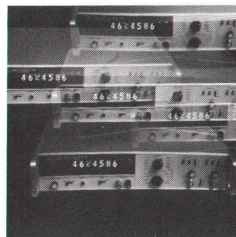

**Cover:** We're not quite sure what, if anything, art director Arvid Danielson is trying to say here. Maybe it's that the new Model 5326B Timer/Counter/DVM is many instruments in one. Anyhow, don't be alarmed; no adjustment of your eyes is necessary.

## In this Issue:

- Timer/Counter/DVM: A Synergistic Prodigy? by Kenneth J. Jochim and Rolf Schmidhauser . . . . . **page 2**
- Measuring Nanosecond Time Intervals By Averaging, by Rolf Schmidhauser . . . . . **page 11**
- High Accuracy AC Calibration to 1100 Volts, by Fred L. Hanson . . . . . **page 14**
- A New Camera for High-Speed Oscilloscope Recording, by Dan Paxton . . . **page 18**



**Fig. 1.** Model 5326B Timer/Counter/DVM is a 50 MHz universal counter and a four-digit integrating digital voltmeter in one package. It has many new capabilities, most notably time-interval averaging and the ability to measure its own trigger level settings. Model 5326A is the same instrument without the DVM.

direct result of being combined with the counter. Features that are quite ordinary for counters, such as variable time base and external clock input, are unusual for DVMs. Hence when the two are combined, the DVM takes on some of the flexibility of a counter. It can have variable integration time, can do scaling or units conversion, or can be set up to reject superimposed input noise of any frequency, such as 60 Hz.

There are still other advantages. For example, there's more convenience and operating simplicity, because there's just one readout, one set of controls, and one package for two instruments. BCD output is optional, and there's only one BCD output connector for the DVM and the counter. Another option makes all front-panel controls except input attenuation and coupling remotely

programmable. Like the BCD option, the programming option has only one connector for both instruments. Thus, in automatic systems which require both a counter and DVM, the combined instrument halves the interface requirements.

#### Two Versions — With and Without DVM

Users who need only a universal timer/counter and not a DVM will find Model 5326A more suitable. It's identical to Model 5326B except that it has no internal DVM.

In both versions, the new timer/counter can serve either as a general purpose lab instrument or as a systems instrument. It has a seven-digit readout (eight optional), and can measure frequencies between zero and 50 MHz

by direct counting. It can measure time interval, period, and multiple-period average, can scale input frequencies by any power of ten up to  $10^8$ , can count random input pulses, and can measure the ratio of two input frequencies. Besides all these more-or-less-usual timer/counter functions, it can — in both versions — average time intervals for increased resolution and accuracy.

### Timer/Counter Operation

Model 5326A/B's block diagram, Fig. 2, has the same major blocks as any counter's, with the exception of the DVM in the B version, and the third input amplifier. There are two counting registers, one the decade counting assembly that accumulates the count to be displayed, and the other the time base divider, which divides its input frequency by  $10^N$ , where N is selected by the front-panel TIME BASE switch. Either the internal clock (frequency standard) or an external clock can be used, the internal one being a 10 MHz temperature-compensated crystal oscillator.

Two of the input amplifiers, those in channels A and B, are identical high-impedance amplifiers, each having its own attenuator and its own trigger level and slope controls. The third input amplifier, channel C, has a  $50\Omega$  input impedance (channels A and B have  $1\text{ M}\Omega$ ) and higher sensitivity (50 mV instead of the 100 mV of

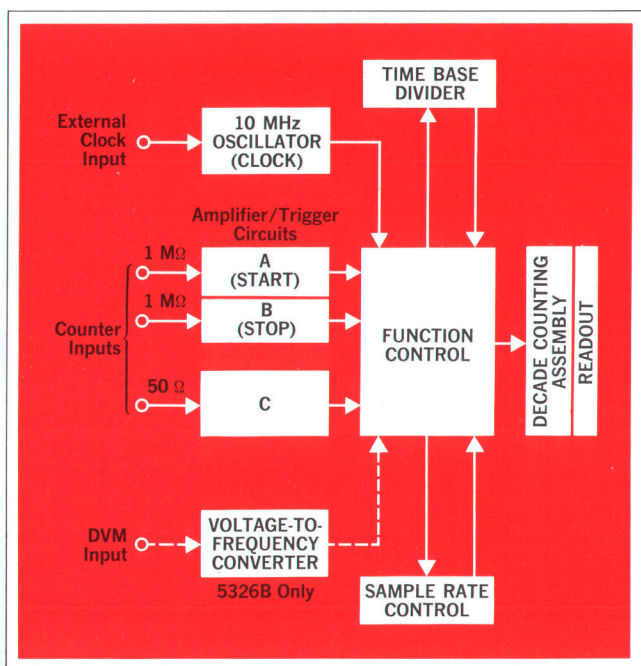
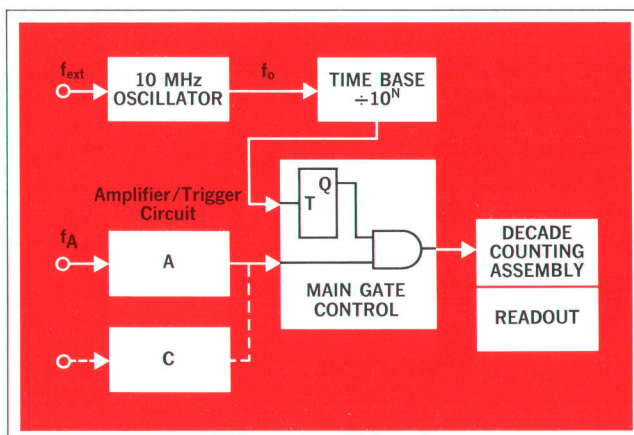

**Fig. 2.** An extra  $50\Omega$  input channel and the B version's DVM distinguish Model 5326A/B's block diagram from that of other counters.

channel A or B). Input C is convenient for measuring signals in circuits that require  $50\Omega$  termination.

### Basic Measurements

Frequency measurements can be made using either channel A or channel C. The input signal is counted for one period of the time base output, which is the clock period times the TIME BASE switch setting (see Fig. 3). The decimal point and annunciator (kHz, MHz, etc.) are automatically positioned in the display.



**Fig. 3.** Frequency measurements can be made using either channel A or channel C. Ratio measurements are made by substituting an external oscillator for the internal clock.

Ratio measurements are simply frequency measurements with the internal 10 MHz frequency standard replaced by a second input frequency,  $f_{ext}$ . The resulting display is  $(f_A/f_{ext}) \times 10^N$ , and decimal points and annunciators are irrelevant.

Burst frequency measurements (Fig. 4) are made using channel A. The instrument always waits in an armed state for an input signal to appear before initiating its gate time or counting cycle.

Measurement of a single period of the input signal is the reciprocal of a frequency measurement. During one period of input signal A, the decade counters count the clock frequency  $f_0$  divided by the setting of the TIME BASE switch, thus displaying  $f_0/10^N f_A$  (see Fig. 5). If  $f_0$  is replaced by an external clock of frequency  $f_{ext}$ , the result is a period-ratio measurement.

Trigger errors in period measurements can be reduced and resolution can be improved by multiple-period averaging. The 10 MHz clock is counted for  $10^N$  periods of input A instead of just one period. This reduces the trigger error by  $10^N$  and increases resolution by the same factor.

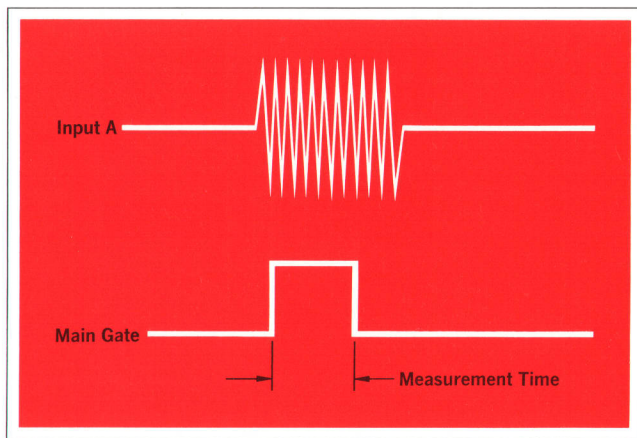

**Fig. 4.** Model 5326A/B measures burst frequencies by waiting in an armed state until an input signal appears in channel A, then measuring for the selected time.

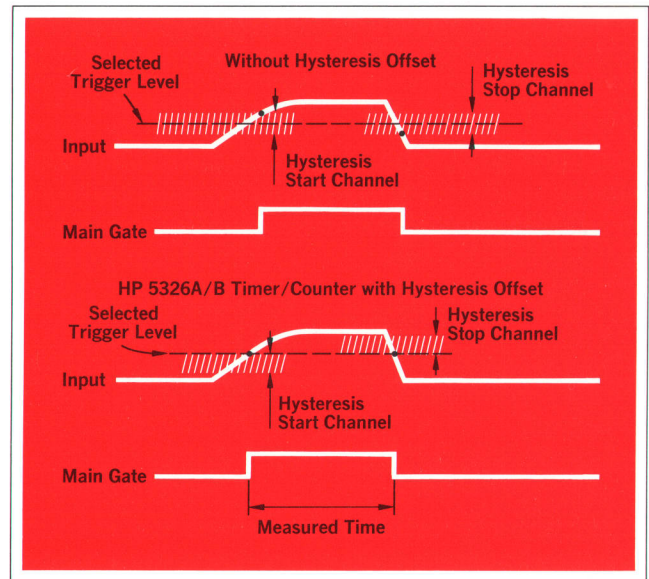

**Fig. 6.** Hysteresis keeps most counters from triggering exactly at the preset levels. Model 5326A/B's hysteresis offset has the same effect as reducing the hysteresis band by a factor of ten or more.

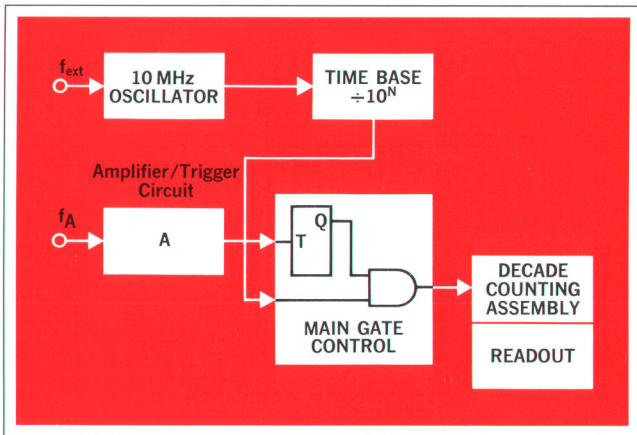

**Fig. 5.** Period and period-ratio measurements are the inverse of frequency and frequency-ratio measurements.

### Hysteresis Compensation Improves Time-Interval Accuracy

Single time intervals are measured very much like single periods, except that the start trigger is derived from channel A and the stop trigger is derived from channel B. A SEP/COM switch connects the inputs of both channels whenever the start and stop signals must be derived from the same waveform, as would be the case in measuring rise times and pulse widths. The unknown time interval is measured by counting the output of the time base divider ( $f_0/10^N$ ) during the time between the start trigger and the stop trigger.

Time-interval measurements can give rise to a variety of special problems. Particularly troublesome is the hysteresis of the Schmitt trigger circuits which follow the input amplifiers (see Fig. 6). Hysteresis causes the circuit to trigger slightly above the selected trigger level on a

rising input voltage, and slightly below the selected level on a falling input voltage. This means, of course, that the time-interval measurement doesn't start or stop exactly where you want it to. However, we have found that this hysteresis is constant for a given circuit, and that it doesn't change significantly with age. Therefore we have built into each Schmitt trigger circuit an offset of half the hysteresis band in either direction, depending upon the setting of the TRIGGER SLOPE switch. The effect is as if the hysteresis band had been reduced by a factor of ten or more, so the voltage where the counter triggers is within a few millivolts of the preset trigger level.

Another problem is how to measure the levels at which the two channels are set to trigger. This is easy with the digital voltmeter in Model 5325B; it will read these levels within 10 mV.

### Trigger Lights

Having minimized the hysteresis and set the trigger levels, the next question is: is the counter triggering? Is the input signal meeting the preset trigger requirements? Can you trust the readings you are getting? The answers are provided by two neon lights on the front panel which indicate proper triggering of channels A and B. Both versions of the new timer/counter have these trigger lights.

An interesting use for the trigger lights and the B version's DVM is to adjust the trigger level until the corresponding trigger light just turns off, then measure

this level, using the READ A or B LEVEL function. The display will be approximately the peak value of the signal in that channel.

### **A New Function: Time-Interval Averaging**

To obtain substantially greater resolution in time-interval measurements than would normally be possible, the new timer/counter averages repetitive time intervals. Here's what this means.

As we've said, a normal counter measures time interval by counting how many cycles of its internal time base occur between a start trigger and a stop trigger. Its best resolution is therefore one clock period. This means that even with a clock frequency of 100 MHz, which is unusually high, the best possible resolution is ten nanoseconds. There are a few exceptions to this; one is the higher-cost HP Model 5360A Computing Counter<sup>1</sup>, which uses an interpolation scheme to get 100-picosecond resolution. The new Model 5326A/B has a 10 MHz clock, and therefore has a resolution of 100 ns in measuring a single time interval. But 100 ns, or even 10 ns, is a long time compared with the rise time or the propagation delay of a logic gate; hence the need for more resolution.

If a time interval occurs periodically, as it usually does in testing, a way to increase resolution and accuracy is to measure several intervals in one measurement cycle. You might, for example, make the same measurement 100 times, totalize the counts, and move the decimal point two places to the left. The result has two more digits than a single-interval measurement, that much is obvious. What isn't so obvious is that, statistically speaking, the standard deviation of the measurement is reduced by a factor of  $\sqrt{100} = 10$ . The only restriction is that the repetition rate of the repeated time interval not be an exact subharmonic of the 10 MHz internal clock, or a multiple of a subharmonic. If averaging lasts for a reasonable length of time, only a slight deviation from these critical frequencies is necessary. The total count accumulated by the decade counters will always be an integral number of 100 ns clock periods, but sometimes a measurement will be a fraction of a clock period less than the unknown time interval, and sometimes it will be a fraction of a clock period more. The average of many measurements will tend towards the exact value, the standard deviation decreasing as the square root of the number of intervals averaged. The resolution of such a multiple measurement improves by this same factor.

This 'square root of the number of intervals averaged' law is valid for unknown time intervals occurring in a

random sequence. When the unknown time intervals have a fixed repetition rate, the improvement in the standard deviation of the average is normally better than the law predicts. We have actually observed that if you have a time interval repeated at a 1 MHz rate and you average  $10^5$  repetitions, you can get ten readings per second and better than 100 ps resolution. You can, therefore, efficiently measure very short rise and fall times and propagation delays through logic circuits, quantities that formerly could only be measured with a sampling oscilloscope or the computing counter.

### **Averaging Scheme Prevents Errors**

To make certain that averaging will indeed improve resolution and accuracy by the theoretical factor, a pair of interconnected synchronizers have been placed in the start and stop channels. This circuit transforms the unknown time interval into multiples of the 100 ns clock period. A pulse from the start or stop channel is first stored in a flip-flop, then transferred at 100 ns intervals through another flip-flop in order to open or close the clock gate (see Fig. 7). The effect of this arrangement is that if we are measuring an unknown time interval of, for example, 205 ns, the instrument will accumulate two counts 95% of the time and three counts 5% of the time. Thus the average would tend toward the true value.

If the stop trigger happens to occur less than 100 ns before the start trigger, the synchronizing circuit treats the two pulses as if they had occurred simultaneously, and the display reads zero. This is important when the unknown time intervals are less than 1 ns, where it's quite probable that small noise fluctuations could reverse the order of the start and stop triggers and cause erroneous readings.\* Calibration is necessary to measure these very short time intervals (see article, page 11), and the 100 ns 'dead zone' makes calibration easier.

### **More About the Digital Voltmeter**

Now we'd like to tell you more about the operation and uses of Model 5326B's DVM. When it isn't being used to measure the trigger levels of the channel A and channel B counter inputs, it can be used to measure dc voltages at its own input. The DVM input is single ended — voltages are measured with respect to chassis ground. Input impedance is high ( $>1000\text{ M}\Omega$  on the 10 V range), so loading errors are minimal.

Typical uses for the DVM would be to measure and adjust power supply voltages, to test bias points in circuits, and to measure circuit linearity. It's basically a

\* Unlike Model 5360A Computing Counter, Model 5326A/B Timer/Counter cannot read negative time intervals.

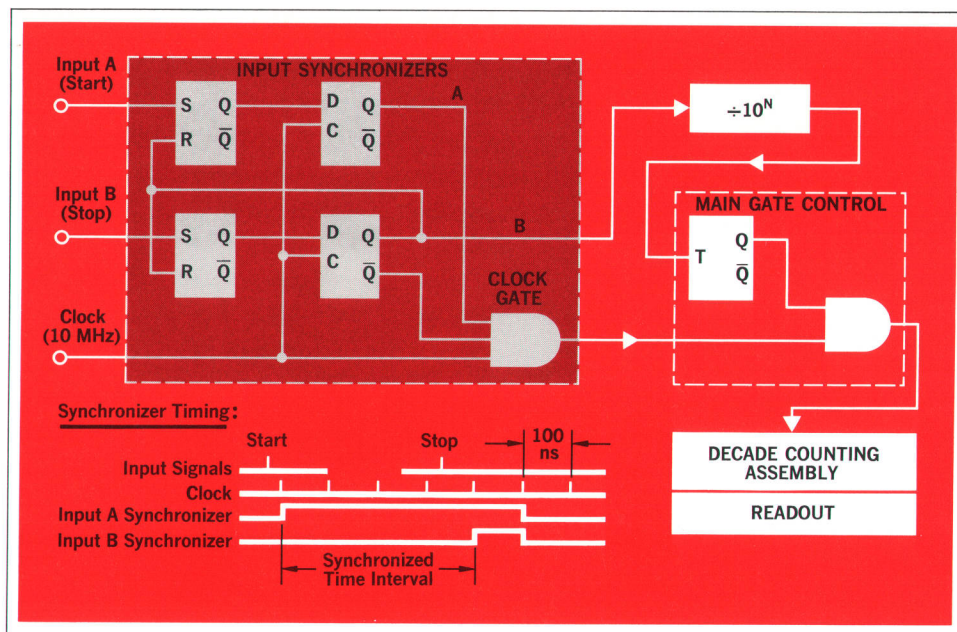

**Fig. 7.** Synchronizing circuit makes certain that a multiple-time-interval average will tend towards the true value. In measuring 205 ns, for example, the counter will accumulate two counts 95% of the time and three counts 5% of the time, provided the repetition rate of the unknown intervals isn't synchronous with the 10 MHz clock.

four-digit DVM, capable of making ten measurements per second. However, as we'll show, the measurement speed and resolution aren't limited to these values.

### Voltage-to-Frequency Converter

Digital voltmeter technology is sufficiently advanced that it's possible to build highly stable analog-to-digital converters at reasonable cost. In Model 5326B, the A-D converter for the DVM is a voltage-to-frequency converter. It produces a pulse train whose frequency is proportional to the input voltage, and the pulse train is counted by the decade counting assembly.

We chose voltage-to-frequency conversion over other DVM techniques mainly for two reasons. First, the linearity is extremely good, and second, since the counter has a variable time base, the DVM can have a variable integration time and therefore variable resolution. A choice of integration times is very useful if the unknown dc input carries superimposed ac noise. The noise will be rejected if its period is equal to the integration time or a submultiple of the integration time, and if the noise is smaller in amplitude than the dc signal.<sup>2</sup>

Fig. 8 is a simplified schematic of the voltage-to-frequency converter. Not shown are the input amplifier and the logic and current source for measuring negative signals. The input voltage  $V_1$  is fed to an integrator, and the integrator output is strobed at intervals of 8  $\mu$ s. If the integrator output is more negative than a reference threshold voltage  $V_{TH}$ , the Q output of the flip-flop goes to its high state, routing the reference current  $I_R$ , which previously flowed through CR2, now through CR1 into

the summing node of the integrator. The clocked operation makes sure that the reference current always changes its path at exactly 8  $\mu$ s intervals or multiples thereof.

The frequency  $f_{in}$  comes into the converter from the counter time base and is equal to the clock frequency  $f_0$  divided by 80. The ratio of the converter output frequency,  $f_{out}$ , to the frequency  $f_{in}$  is the duty cycle of output Q being high, or the proportion of time that output Q is in its high state. This duty cycle,  $\delta$ , is proportional to  $V_1$ , as the following equations show.

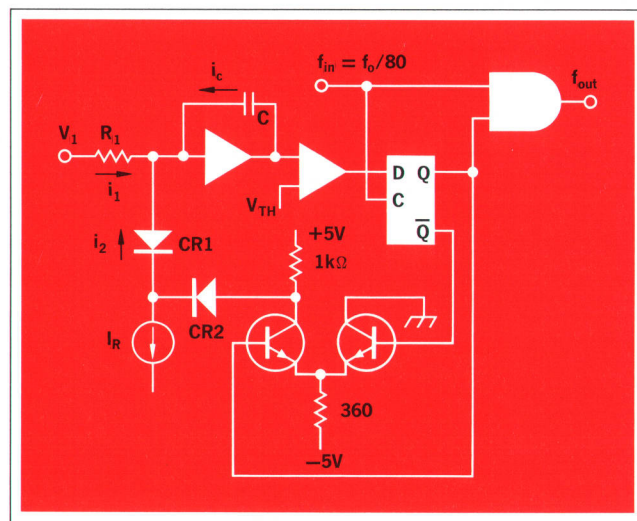

**Fig. 8.** This circuit in Model 5326B converts the DVM input voltage to a proportional frequency, which is then counted by the counter section. Linearity is better than 0.01%.

$$\int_0^T (i_1 + i_2 + i_c) dt = 0$$

$$i_1 = \frac{V_1}{R_1}$$

$$i_2 = -I_R \delta$$

$$\int_0^T i_c dt \rightarrow 0$$

Therefore,  $V_1 = I_R R_1 \delta = I_R R_1 \frac{f_{out}}{f_{in}}$ .

The converter has better than 0.01% linearity and short-term stability. Emitter-coupled logic circuits are used to make sure that the clock intervals and switching times are also stable within 0.01%, or 0.8 ns.

### Variable Resolution

After the input voltage has been converted to a proportional frequency, the counter treats it like any other frequency input. Changing the gate time of the counter changes the resolution of the DVM readout. With the TIME BASE switch set to 1 ms, 10 ms, 100 ms, 1 s, or 10 s, the number of digits displayed is 2, 3, 4, 5, or 6, respectively. Notice the tradeoff between speed and resolution: the DVM can make up to 99 three-digit measurements (10 mV resolution) or just one five-digit measurement (100  $\mu$ V resolution) per second.

For most measurements, the basic integration time of 100 ms is most useful. It gives four-digit accuracy and rejects superimposed line noise of 50 Hz and 60 Hz, 100 ms being a multiple of both line periods.

### Continuously Variable Integration Time

Since the counter has an external clock input, the frequency  $f_{in}$  coming from the clock to the V-f converter can be anything the user wants. This opens up a variety of scaling and integrating applications.

An external clock frequency affects  $f_{in}$  and the measurement time simultaneously, and the displayed voltage remains the same without loss of accuracy. However, a different measurement time is often of great value. For example, suppose a relatively fast measurement, say 10 ms, is desirable, but the input signal has 60 Hz hum superimposed on it. A 6 MHz external clock can be used to change the measurement time to 16.7 ms, still relatively fast, but of the correct duration to average out the hum.

When Model 5326B is being remotely programmed, it's even more flexible. Simultaneously closing contacts on the DVM and PERIOD A function lines causes the instrument to accept the period of the signal in channel

A as the integration time and the DVM input signal as the analog quantity to be integrated (see Fig. 9). If the period of signal A is  $T_A$  seconds, the voltmeter input is scaled by a factor of  $T_A$  when compared with a one-second measurement.

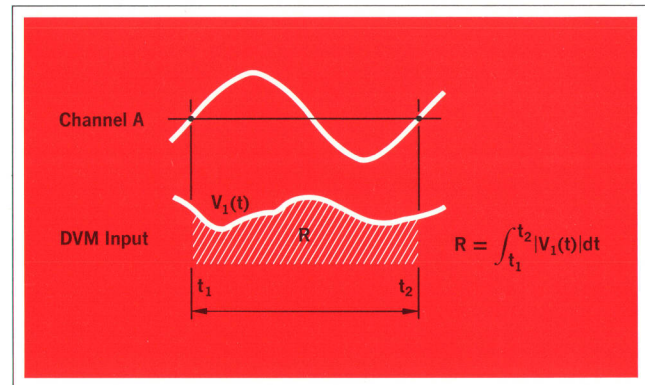

**Fig. 9.** By remotely programming Model 5326B for both PERIOD A and DVM, the instrument can be made to measure the integral of the DVM input over the period of input signal A. This is useful in scaling or units conversion. See Fig. 10.

A typical scaling application is the diode temperature sensor of Fig. 10. Here the object is to convert electrical units to engineering units. A 1°C temperature rise decreases the voltage across the diode by roughly 2 mV, or 2 digits in a 100 ms measurement. Connecting a 2 Hz signal to input A and programming both DVM and PERIOD A multiplies the reading by five and displays the result directly in °C with 0.1°C resolution. An appropriate offset voltage must be applied in series with the diode, of course.

Before leaving the DVM, here's a word of caution. V-f converters cannot integrate bipolar signals. Hence the result displayed by Model 5326B is the integral of the *absolute* value of  $V_1$  over the selected measurement time. The displayed sign is the one detected at the end of the measurement.

### Remote Programming

All of Model 5326A/B's front-panel controls except input attenuation and coupling are remotely programmable. All programmable functions except trigger levels are programmed by single-line contact closures to ground, saturated low-voltage transistors, or five-volt saturated (DTL type) logic. Trigger levels are programmed by analog dc voltages between +3 V and -3 V. Decimal points and units annunciators are displayed automatically and need not be separately programmed.



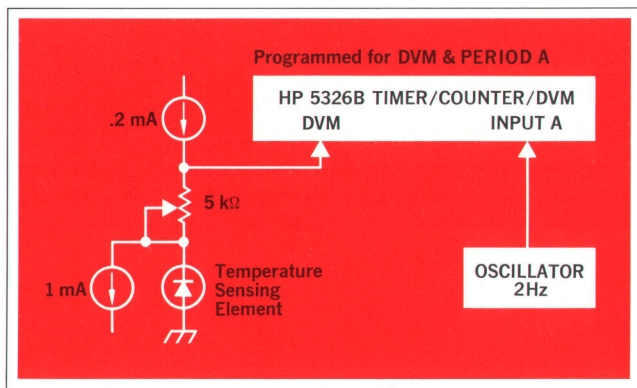
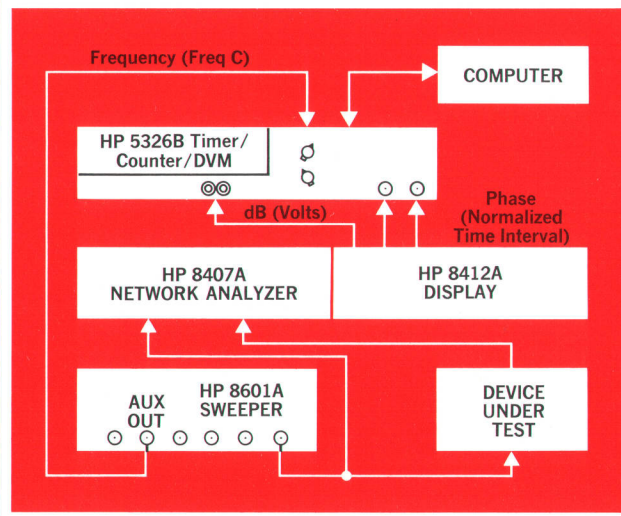

**Fig. 10.** Units conversion with Model 5326B. The temperature of the diode can be read directly in °C with 0.1°C resolution. The channel A input normalizes the reading.

## A Network Analyzer With Digital Readout

A programmable timer/counter/DVM is an extremely valuable component for automatic systems. In the example shown here, Model 5326B Timer/Counter/DVM is interfaced with Model 8407A/8412A Network Analyzer (Hewlett-Packard Journal, December 1969). Model 8412A is modified such that two phase outputs are brought out to be connected to inputs A and B of the timer/counter/DVM. Model 8412A's magnitude output is connected to the DVM input. The auxiliary output of the sweeper driving the network analyzer is connected to Model 5326B's C input.

By simply changing Model 5326B's FUNCTION switch — or programming it remotely — through FREQ C, T.I.AVG A-B, and DVM, the frequency, phase, and magnitude of the parameter being measured by the network analyzer can be displayed digitally and output in BCD to a printer or computer. Under automatic control these three measurements can be made and printed in something less than one second; hence high-speed data acquisition is feasible.



## Acknowledgments

Packaging two instruments in one unit took a good deal of expert mechanical design. Thanks to Glen Elsea, the instrument is both attractive and easy to service. We would also like to thank Tom Mingle for his design of the room-temperature crystal oscillator. The initial product definition was done by Tom O'Brien, who created the new functions READ A and B LEVEL. 

## References

- [1] G. B. Gordon and G. A. Reeser, 'Introducing the Computing Counter,' *Hewlett-Packard Journal*, May 1969.
- [2] B. Kay and J. L. Harmon, 'Twelve Functions in a New Digital Meter,' *Hewlett-Packard Journal*, March 1969.

### Kenneth J. Jochim



Ken Jochim is project leader for the 5326 family of instruments. He is a 1966 BSEE graduate of Rensselaer Polytechnic Institute, and he came to HP's Santa Clara Division in 1968 after working for two years in the development of electromechanical servo systems. When Ken isn't designing counters he occupies his time with numerous hobbies and activities, including sports cars (preparation, touring, and racing), photography, skindiving, radio-control models, camping, woodworking, and ham radio.

### Rolf Schmidhauser



Rolf Schmidhauser designed many of the circuits in the 5326A/B Timer/Counter. At HP since 1968, he is a 1965 graduate of the Swiss Federal Institute of Technology, Zurich. He holds the degree Diplom-Ingenieur in electrical engineering. As a result of his work on the 5326A/B and previous instruments, Rolf has several patents pending. He is presently working on some special IC's for the 5326 family, and he plans to continue in IC development in the future. For relaxation, he likes to go hiking in the Sierra Nevada and in the foothills.

## SPECIFICATIONS

### HP Model 5326A/B Timer/Counter

#### INPUT CHANNELS A AND B

RANGE: dc coupled: 0–50 MHz.

ac coupled: 20 Hz–50 MHz.

SENSITIVITY (min.): 0.1 V rms sine wave

0.3 V p-p pulse.

8 ns minimum pulse width.

Sensitivity can be decreased by 10 or 100 times, using the ATTENUATOR switch.

IMPEDANCE: 1 M $\Omega$  shunted by less than 25 pF.

DYNAMIC INPUT VOLTAGE RANGE:

0.1 to 3 V rms ac times attenuator setting.

$\pm 5$  V dc times attenuator setting.

TRIGGER LEVEL: PRESET to center triggering about 0 V or variable over the range of  $-3$  V to  $+3$  V times attenuator setting. Trigger threshold band  $< 1.0$  mV, referred to input at maximum frequency.

SLOPE: Independent selection of positive or negative slope.

#### INPUT CHANNEL C

RANGE: dc coupled: 0–50 MHz.

SENSITIVITY: 50 mV rms sine wave.

10 ns minimum pulse width.

IMPEDANCE: 50 $\Omega$  nominal.

MAXIMUM INPUT:  $\pm 5$  volts.

TRIGGER LEVEL: 0 volts.

#### START

(Totalizing and Scaling)

RANGE: 0–10 MHz.

FACTOR: 1–10<sup>8</sup> selectable in decade steps.

OUTPUT: Rear panel TIME BASE BNC.

DISPLAY: Channel A input divided by scaling factor.

#### FREQUENCY

RANGE: 0–50 MHz.

INPUT: Channel A or Channel C (switchable).

Channel A provides triggered frequency measurement capability.

GATE TIMES: 0.1  $\mu$ s to 10 s in decade steps.

ACCURACY:  $\pm 1$  count  $\pm$  time base accuracy.

DISPLAY: MHz or kHz with positioned decimal point.

#### TIME INTERVAL

RANGE: 0.1  $\mu$ s to 10<sup>9</sup> seconds.

INPUT: Channels A and B; can be common or separate.

FREQUENCY COUNTED: 10 MHz to 0.1 Hz in decade steps.

ACCURACY:  $\pm 1$  count  $\pm$  time base accuracy  $\pm$  trigger error.\*

DISPLAY:  $\mu$ s, ms, seconds or 10's of seconds with positioned decimal point.

#### TIME INTERVAL AVERAGE

RANGE: 0.15 ns to 10 s.

INTERVALS AVERAGED: 1–10<sup>8</sup> selectable in decade steps.

INPUT: Channels A and B; can be common or separate.

FREQUENCY COUNTED: 10 MHz.

ACCURACY:  $\pm$  time base accuracy  $\pm 2$  ns  $\pm$  (trigger error\*  $\pm 100$  ns)

$\sqrt{\text{number of intervals averaged}}$

DISPLAY: ns,  $\mu$ s with positioned decimal point.

#### PERIOD

RANGE: 0–10 MHz.

INPUT: Channel A.

FREQUENCY COUNTED: 10 MHz to 0.1 Hz in decade steps.

ACCURACY:  $\pm 1$  count  $\pm$  time base accuracy  $\pm$  trigger error.\*\*

DISPLAY:  $\mu$ s, ms, seconds or 10's of seconds with positioned decimal point.

#### PERIOD AVERAGE

RANGE: 0–10 MHz.

PERIODS AVERAGED: 1–10<sup>8</sup> selectable in decade steps.

INPUT: Channel A.

FREQUENCY COUNTED: 10 MHz.

ACCURACY:  $\pm 1$  count  $\pm$  time base accuracy  $\pm$  trigger error.\*\*

DISPLAY: ns,  $\mu$ s with positioned decimal point.

#### TIME BASE

CRYSTAL FREQUENCY: 10 MHz.

STABILITY:

AGING RATE:  $< 3$  parts in 10<sup>7</sup>/mo.

TEMPERATURE:  $\leq \pm 2.5$  parts in 10<sup>6</sup>, 0° to 50°C.

LINE VOLTAGE:  $\leq \pm 1$  part in 10<sup>7</sup> for 10% line variation.

EXTERNAL INPUT: 100 Hz–10 MHz; 1 V rms into 1 k $\Omega$ .

#### INTEGRATING DIGITAL VOLTMETER

(5326B Only)

TECHNIQUE: Voltage-to-frequency conversion.

VOLTAGE RANGES: Manual selection.

RANGE (V dc)	RESOLUTION (1 s integration time)	INPUT IMPEDANCE
10	100 $\mu$ V	$> 1000$ M $\Omega$
100	1 mV	10 M $\Omega$
1000	10 mV	10 M $\Omega$

INPUT: Single ended.

POLARITY: Automatic polarity detection.

OVERRRANGE: 25% overrange on 10 V and 100 V ranges with full accuracy.

OVERLOAD PROTECTION: 1100 V dc all ranges.

ACCURACY: After 10 minutes warm-up, within 10°C to 40°C temperature range, less than 80% relative humidity, within 90 days of calibration:

RANGE	STABILITY (% of Reading)	LINEARITY (% of Range)	ZERO DRIFT (% of Range)	COUNTER
10 V	$\pm 0.04\%$	$\pm 0.01\%$	$\pm 0.01\%$	$\pm 1$ count
100 V	$\pm 0.04\%$	$\pm 0.01\%$	$\pm 0.01\%$	$\pm 1$ count
1000 V	$\pm 0.08\%$	$\pm 0.01\%$	$\pm 0.01\%$	$\pm 1$ count

MEASUREMENT TIME:

1 ms 2 digits

10 ms 3 digits

100 ms 4 digits

1 s 5 digits

10 s 6 digits

} Decimal points automatically displayed.

RESPONSE TIME:  $< 100$   $\mu$ s for full accuracy with a step function input.

AC NOISE REJECTION: Infinite for multiples of (measurement time)<sup>-1</sup>.

#### GENERAL

(5326A and 5326B)

DISPLAY: 7 digits (8 optional).

BLANKING: Suppresses display of unwanted zeros left of the most significant digit.

DISPLAY STORAGE: Holds reading between samples. Rear panel switch overrides storage.

SAMPLE RATE: FAST position: Continuously variable from less than 100  $\mu$ s to approximately 20 ms. NORM position: Continuously variable from less than 20 ms to approximately 5 seconds. HOLD position: Display can be held indefinitely.

OVERFLOW: Neon indicates when display range is exceeded

OPERATING TEMPERATURE: 0° to 50°C (See DVM accuracy).

OPTION 001: 8-digit display.

PRICE: \$75.00.

OPTION 002: Remote programming.

CONTROLS: All front panel controls are single line programmable except:

SEP-COM (separate common) switch; the check function is programmable.

FAST/NORM Mode.

Input Attenuators.

AC/DC Input Signal Coupling.

CONTROL SIGNAL: Single line control using either contact closure to ground or DTL drive on all lines except trigger levels which are analog programmed ( $\pm 3$  V dc).

PRICE: \$75.00.

OPTION 003: Digital output (for numerals and polarity only).

CODE: 4-line 1-2-4-8 BCD, '1' state high.

'0' state  $+0.25$  V at  $-1$  mA; '1' state:  $+5$  V open circuit, 2.5 k $\Omega$  source impedance, nominal.

PRINT COMMAND:  $+5$  V to 0 V dc coupled; occurs at end of gate. STORAGE: Buffer storage is provided so BCD output is constant while next measurement is being made.

INHIBIT INPUT: Inhibits gate when instrument's cycle time is less than the time required for external equipment to interrogate BCD outputs. Positive inhibit  $+5$  V dc.

PRICE: \$50.00.

PRICE: 5326A: \$1,195.00

5326B: \$1,550.00.

MANUFACTURING DIVISION: HP Santa Clara Division

5301 Stevens Creek Boulevard

Santa Clara, California 95050

\* For any waveshape, trigger error is less than  $\pm \frac{0.0025}{\text{Signal Slope (V/\mu s)}} \mu\text{s}$ .

\*\* Trigger error is less than  $\pm 0.3\%$  of one period  $\div$  periods averaged for signals with 40 dB or better signal-to-noise ratio and 100 mV rms amplitude.

# Measuring Nanosecond Time Intervals By Averaging

*What kind of resolution can you get and how do you get it? What about accuracy?*

By Rolf Schmidhauser

THE BEST RESOLUTION CURRENTLY AVAILABLE in counter time-interval measurements is achieved by the HP 5360A Computing Counter with the HP 5379A Time Interval Plug-in. This combination can measure single time intervals with 100 picosecond resolution. Properly programmed, either by a computer or by its calculator-like keyboard, the computing counter can *average* multiple time-interval measurements and thereby resolve time intervals down to ten picoseconds or less.

General-purpose medium-cost counters, on the other hand, can't have the computing counter's interpolators and arithmetic capability, for reasons of cost. They *can*, however, have *averaging* capability, and the HP 5326A/B Timer/Counter has it (see article, page 2). Of course, the timer/counter never matches the computing counter, since it starts with a basic resolution of 100 nanoseconds instead of 100 picoseconds. But it can and does resolve better than 100 ps, and that's a real advance over ordinary counters.

Time-interval averaging is always possible if the unknown time interval occurs repeatedly and has a repetition rate high enough to allow averaging  $10^3$  to  $10^6$  intervals in a reasonable length of time, say one second or less. The only absolute restriction is that the repetition rate of the unknown time intervals not be an exact multiple of a subharmonic of the timer/counter's internal clock rate, which is 10 MHz. Averaging over more than  $10^6$  intervals and times longer than one second would theoretically give progressively better resolution. However, the short-term stability of the counter's measuring scheme imposes practical limits.  $10^5$  measurements, made at a rate close to — but not exactly equal to — 1 MHz, is a good compromise; 10 averaged measurements will be completed each second.

## Accuracy and Resolution

Fig. 1 compares the accuracy and resolution attainable in a single measurement and in an average of  $10^5$  measurements. The multiple measurement is accurate within  $\pm 2$  ns, a limit established by the degree to which the

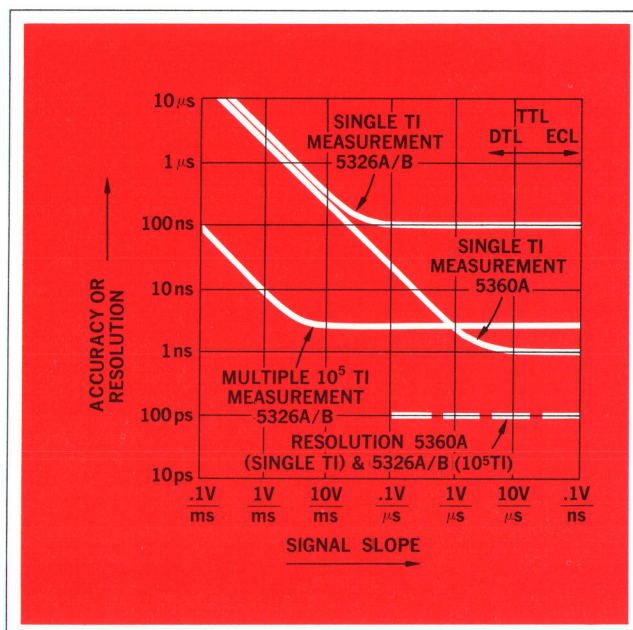

**Fig. 1.** In single time-interval measurements, Model 5326A/B Timer/Counter's accuracy is  $\pm 100$  ns and resolution is 100 ns. In an average of  $10^5$  measurements, accuracy is  $\pm 2$  ns, and resolution is better than 100 ps. Accuracy can be improved by calibration (see text). Model 5360A Computing Counter's accuracy and resolution are shown for comparison. Sloping parts of all curves are due to internal noise.

propagation delays of Model 5326A/B's start and stop channels are matched. This compares with  $\pm 100$  ns for the single measurement. The  $\pm 2$  ns limitation is a systematic error which can be overcome by calibrating the instrument before a measurement, using a method which will be explained later. Properly calibrated, the accuracy of the multiple measurement can approach its resolution which, as Fig. 1 shows, is a thousand times better than the resolution of a single measurement — 100 ps instead of 100 ns. This thousand-times improvement can be achieved without difficulty. Notice that it is slightly better than the improvement predicted by dividing by the square root of the number of intervals averaged.

The sloping part of the curves of Fig. 1 is due to internal noise, which results in trigger errors. The effect of such noise decreases as the input signal's slope increases. When measuring rise times and propagation delays of integrated logic circuits (DTL, TTL, ECL), this noise can normally be ignored.

For comparison, the resolution and accuracy of Model 5360A Computing Counter in measuring a single time interval are also shown in Fig. 1. The computing counter achieves  $\pm 1$  ns accuracy and 100 ps resolution in just one measurement. It will do even better in a multiple measurement.

### Measuring Fast Rise Times

Model 5326A/B's start and stop channel input amplifiers are designed for a broad range of applications. This means they are linear circuits which have high input impedance, good sensitivity, and a bandwidth exceeding that of the counting decades. When measuring fast-rise time pulses, however, the user must understand the input amplifiers and use them properly.

One point that is often overlooked is proper termination of connecting cables. When a pulse source is connected to the timer/counter, it is unlikely that the pulses will arrive at the counter terminals without degradation unless the cable is terminated in its characteristic impedance.

Fig. 2 shows the three commonly used integrated-circuit logic families and the circuits recommended for interfacing them with the timer/counter. ECL circuits can be terminated at the source, so their full voltage swing is available at the counter input.

Fig. 3 shows what happens when a cable is improperly terminated. In this case the source is an emitter-coupled logic (ECL) gate. It is connected to the counter through a 50 $\Omega$  coaxial cable. The resulting reflections and loading can cause double counts and inaccurate measurements.

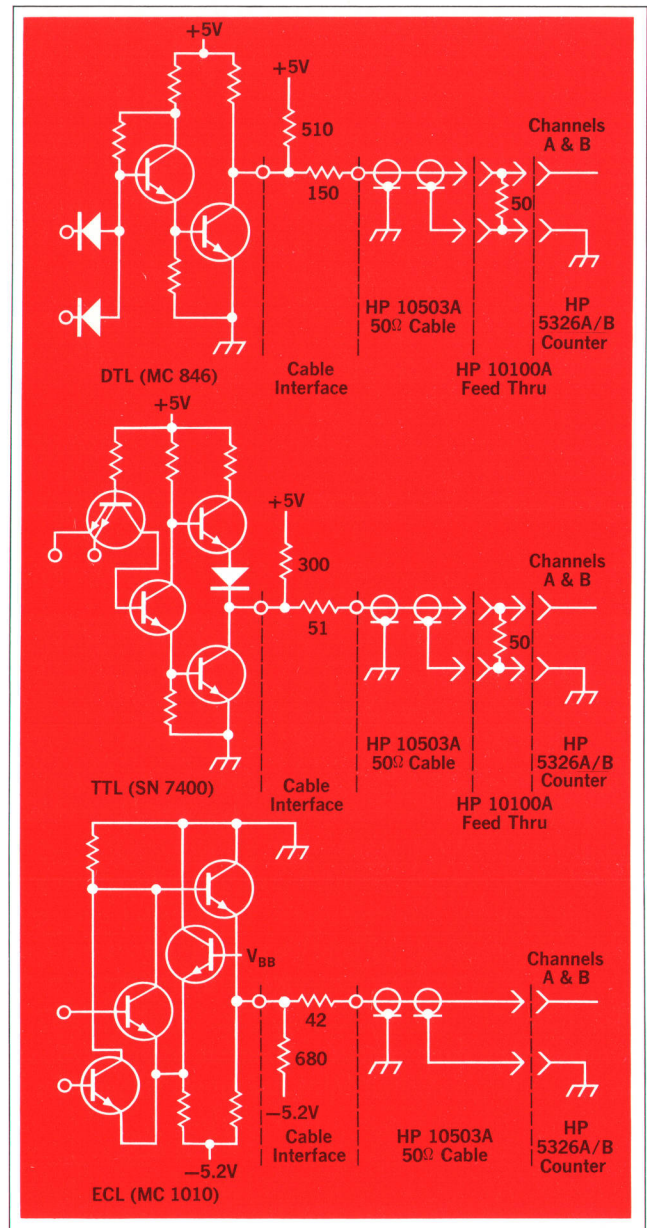
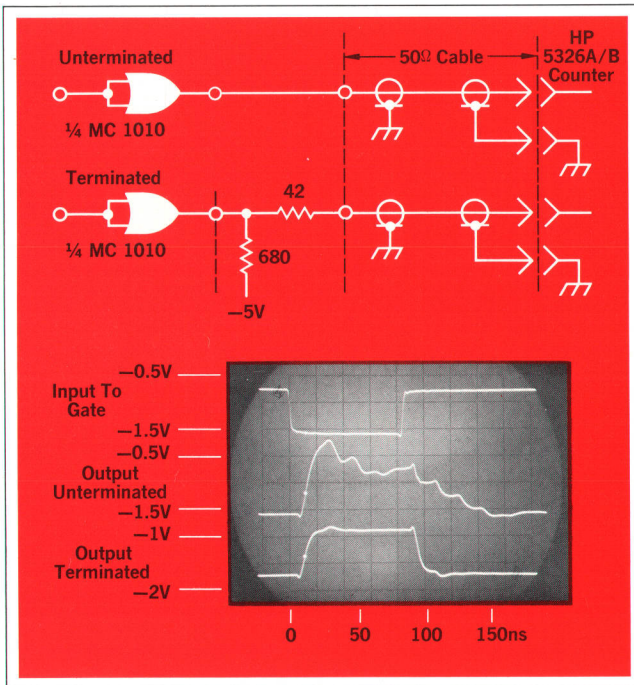

Fig. 2. Recommended interface between integrated logic circuits and counter.

Another problem that's often overlooked is the finite rise time of the counter's input amplifiers. If a pulse has a rise time less than 10 ns, its rise time can't be measured simply by adjusting the counter's trigger levels to the 10% and 90% points. This method is likely to give results approaching the rise time of the input amplifiers, instead of that of the applied signal.

This problem can be overcome to some extent by taking advantage of the matched (within 2 ns) response times of the counter's start and stop channel amplifiers. To do this requires generating appropriate start and stop pulses



**Fig. 3.** Output of an ECL gate connected to Model 5326A Timer/Counter, first using only a 50Ω cable (middle trace) and then a 50Ω cable with the proper series termination. Reflections resulting from improper termination can cause double counts, incorrect readings.

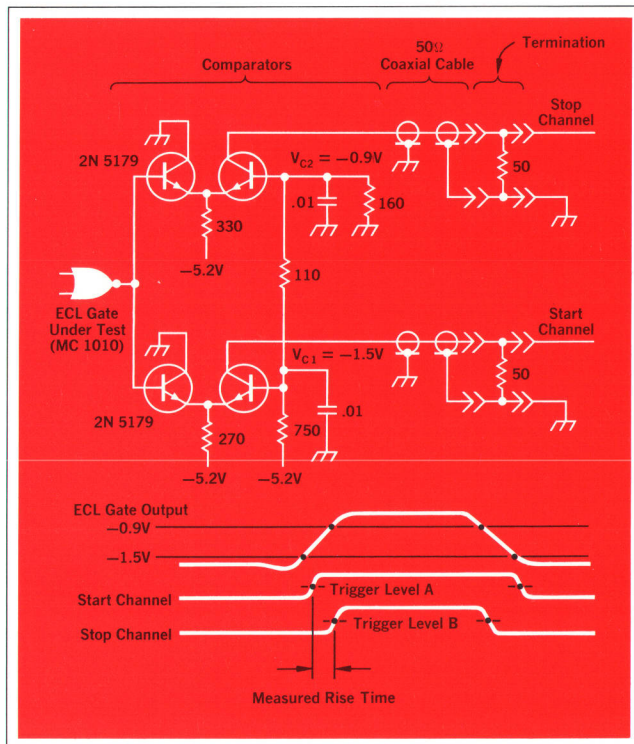

**Fig. 4.** Measuring rise times comparable to those of Model 5326A/B's input amplifiers (about 6 ns) requires special techniques. Here is a method that uses local comparators (see text).

—e.g., of either polarity, but the same magnitude and rise time—and setting the trigger levels to the same amount off the base line. The following example illustrates this technique.

### Measuring Rise Time With Local Comparators

Fig. 4 shows a typical measurement setup for an ECL gate. Two simple comparators located right next to the gate generate pulses of identical amplitude and rise time into their 50Ω loads. The rise time of the gate induces a time delay between the leading edges of the pulses, and the gate's fall time induces a delay between the trailing edges of the pulses. Trigger levels in channels A and B of the timer/counter are set to the same voltage. Set up as in Fig. 4 the circuit measures the rise time of the gate. The fall time is measured by reversing the two channel inputs and switching the TRIGGER SLOPE controls to minus.

How accurate this measurement can be depends to a large extent on the local comparator. With the comparators shown, rise times can be measured within 2 ns, which is the degree to which the response times of the start and stop channels are matched. There is a variety of IC comparators that can also be used—for example,  $\mu$ A 710 or LM 106. These have high gain and high input impedance, but are somewhat complex, and their propagation delays may vary as much as 20 ns with input signal rise time and amplitude. Their usefulness is restricted to the measurement of rise times greater than about 10 ns.

### Calibration Improves Accuracy

If  $\pm 2$  ns accuracy is insufficient, a simple calibration procedure can be used to improve accuracy. Calibration will permit short-term accuracies approaching the resolution of the measurement. If  $10^5$  intervals are averaged, for example, a calibrated measurement can be accurate within about 0.2 ns.

In the setup of Fig. 4, calibration is accomplished by connecting the comparator levels together, so that  $V_{c1} = V_{c2}$ , then offsetting the channel A or B trigger level slightly until the readout comes very close to zero. This changes the delay through one of the channels and compensates for the systematic mismatching. Calibration should be repeated when changing the trigger slope settings.

Calibration by trigger level adjustment is usually possible, but when it isn't, a variable length of line can be inserted in one of the input cables and adjusted until the display reads nearly zero with the same signal going into both input cables.  $\square$

# High Accuracy AC Calibration to 1100 Volts

By Fred L. Hanson

PRECISION DC VOLTAGES FOR INSTRUMENT CALIBRATION have generally been easy to obtain. Calibration of dc voltmeters is not complicated and can be performed fairly rapidly. Calibration of precision ac voltmeters, however, is more complex. The voltage source must be capable of producing an output of high spectral purity over a broad frequency range. Measurements have generally been made using the time-consuming thermal transfer technique.<sup>1</sup>

With the introduction of the HP Model 745A AC Calibrator, one compact instrument produced high accuracy ac voltages from  $100\mu$  V to 110 V, at 10 Hz to 110 kHz. Using a new automatic ac-to-dc thermal transfer technique, this instrument makes calibration measurements twice per second. Now, a companion instrument designed to be used with the Model 745A, extends the voltage output up to 1100 V. The HP Model 746A High Voltage Amplifier, Fig. 1, is used in the same manner as the other voltage ranges of the Calibrator.

## How Does the System Work?

The 745A/746A Block Diagram shown in Fig. 2 illustrates the operation of the 1000 V range. The voltage set dials on the 745A front panel are set to 1018.476 V. The 1000 V range is selected on the 745A panel and the OUTPUT ON pushbutton on the front panel of the 746A is pressed to obtain an output. The feedback loop in the 745A senses the voltage on the feedback line and adjusts the voltage input to the high-voltage amplifier until the

feedback signal is 1/1000th of the desired output signal. Since the output divider is of 1000:1 ratio, the output voltage of the 746A is 1000 times the feedback signal, which is the desired output voltage. The gain of the control loop that adjusts the voltage input to the 746A is 100 dB, or  $10^5$ . This means that if the gain of the 746A changes by 1%, the output voltage will change by 1% divided by  $10^5$  or 0.1 ppm.

System accuracy is quite independent of the gain accuracy of the high-voltage amplifier. The midband calibration of the 1000 V range can be done either with a thermal transfer measurement or the ratio of the divider can be set so that the dc ratio is 1000:1. This is done with both the 745A generator and the 746A amplifier turned off. A 1000 V dc signal is then applied to the 746A output connector and the divider ratio adjusted until the feedback signal is 1 V dc. After the midband calibration is completed, it is only necessary to make one thermal transfer measurement to set the frequency response on at 100 kHz. Since the 1000:1 divider is almost completely resistive over the entire frequency range, the long term stability of calibration is essentially that of a good wirewound resistive divider. These resistors are in hermetically sealed cans and have excellent long term stability.

Many of the problems associated with a 1000 V range are similar to those for lower voltages. One of these problems, switching transient generation, is avoided in the 746A by eliminating the step-up transformer to gen-

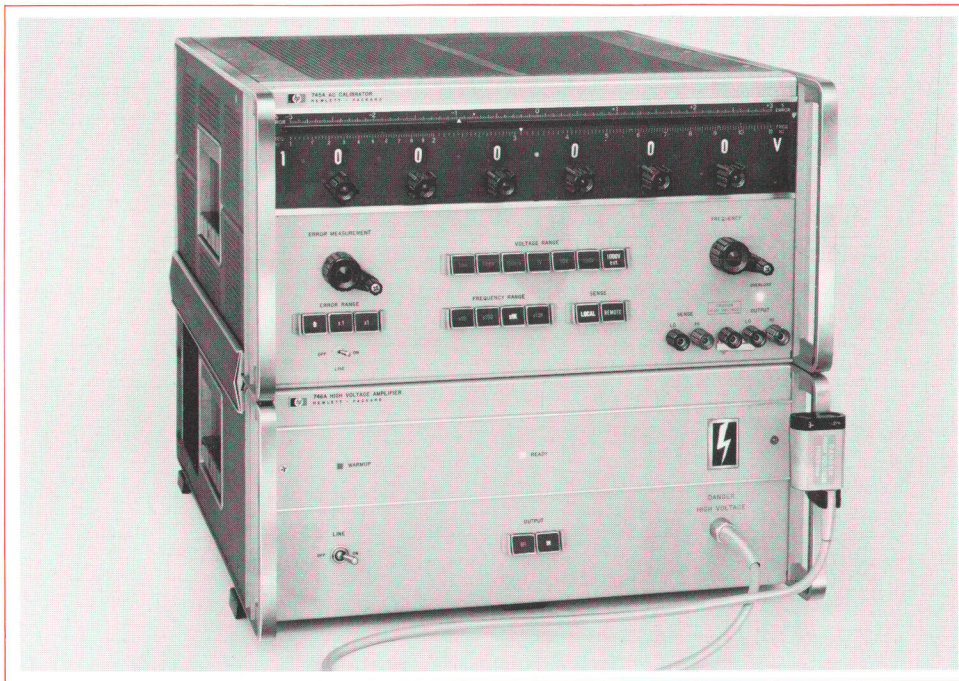

**Fig. 1.** Combining the Model 746A High Voltage Amplifier (lower unit) with the Model 745A AC Calibrator makes available ac calibration voltages to 1100 V in one instrument.

erate the high voltage output. The controlled turn-on characteristic eliminates any harmful transient when the output is turned on. Transient-free operation, when a frequency change is made, is assured by transient-free operation of the driving source (745A).

Distortion is another important problem associated with high accuracy ac calibration. Distortion added by the 746A to its input signal is not significant. Total harmonic distortion is  $-66$  dB over the entire 10 Hz to 110 kHz frequency range. More important, the maximum error introduced between average responding and true rms responding instruments is less than 0.005%.

### Circuit Details

Ceramic base tubes handle the high voltage and power, and transistors provide most of the control function. The amplifier uses operational feedback as an overall feedback scheme with local feedback to reduce the effects of local nonlinearities, Fig. 3. Current drawn by the adjustable current generator from the summing junction must be supplied through the feedback resistor. This establishes the dc bias voltage on the amplifier output (+1820 V dc). The amplifier at the operational summing junction is a 'voltage in, current out' amplifier. A low-distortion current output waveform results from a low-distortion voltage input. This current drives into the cathode of a grounded-grid tube to provide a low-distortion voltage at the plate of the tube, and reduces

the effect of the nonlinear grid cathode characteristic of the tube V1. The ac voltage at the plate of V1 is essentially equal to the output voltage.

The buffer amplifier is necessary to furnish large amounts of current into a load without introducing changes of gain or bandwidth in the amplifier. It has a low output impedance and high input impedance over a wide bandwidth. Tubes V2 and V3 are used to main-

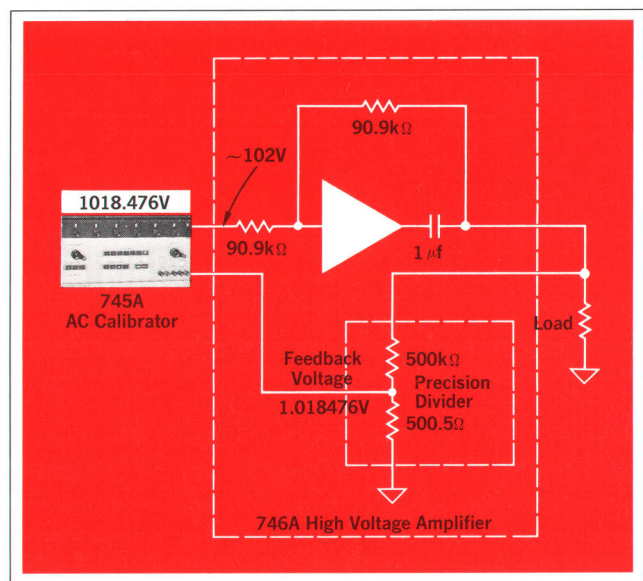

**Fig. 2.** Operation of the 745A/746A on the 1000 V range. Feedback voltage is 1.018476, or 1/1000 of the voltage set on the calibrator dials.

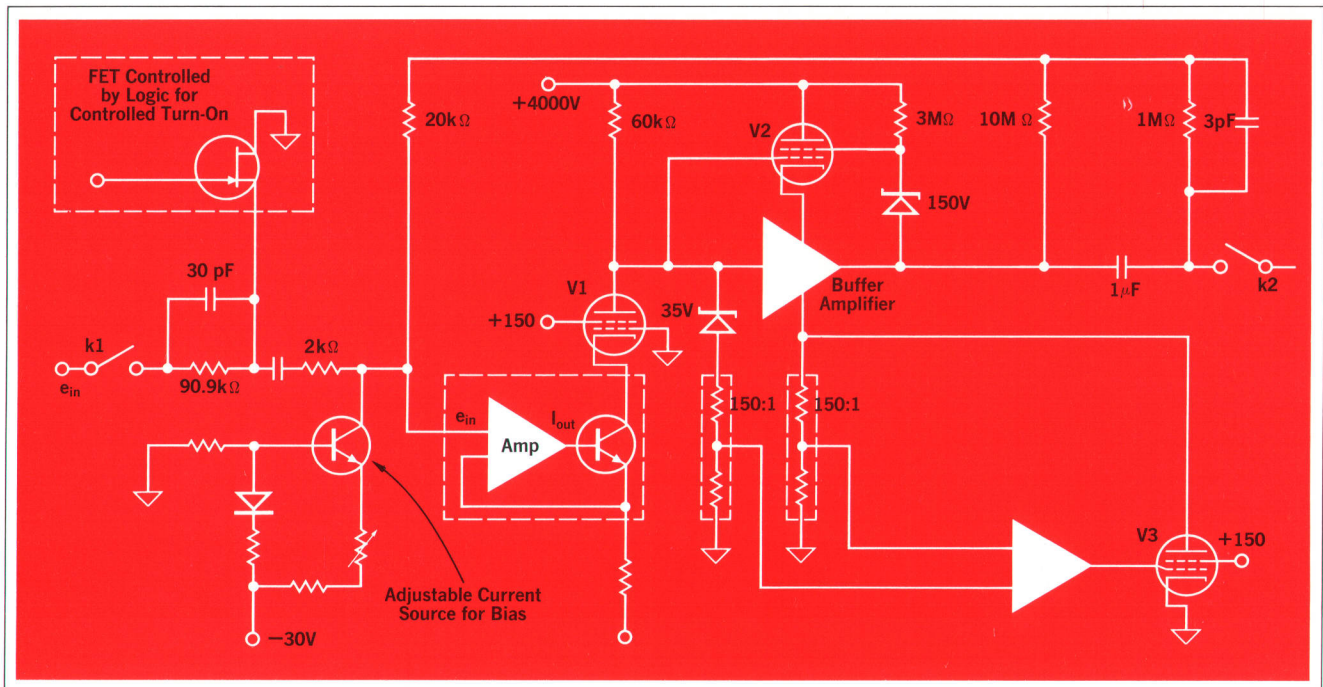

Fig. 3. Three vacuum tubes handle high voltage and power in the Model 746A. Logic circuitry controls the turn-on sequence.

tain a reasonable voltage (about 30 V) across both the plus and the minus halves of the buffer amplifier. This is done on the positive side of the buffer by connecting the grid of V2 to the buffer input voltage. The supply voltage for the buffer (cathode of V2) is about +30 V at low current out, and down to +5 V at 25 mA. The operation of V3 is different simply because an opposite polarity tube is not available. In this case the voltage across the buffer amplifier is sensed through a pair of identical 150:1 dividers. An amplifier senses the difference in the output levels of the two dividers and drives the tube until the voltage at the top of the second divider (plate of V3) is equal to that at the top of the input divider. A 35 V zener diode provides a -35 V difference that serves as a power supply voltage for the bottom half of the buffer amplifier.

### Controlled Turn-on

When the OUTPUT ON button is pushed, the logic, Fig. 3, first checks to make certain that the 1000 V range has been selected on the 745A front panel. If this is the case, the turn-on sequence proceeds. Up to this time, K1 and K2 are open and the FET is shunting out the signal path. The first step in the turn-on sequence closes K2. Since there is no input voltage connected at this time, there is no output. About 20 ms later K1 closes, provid-

ing input voltage to the amplifier, but the FET is shunting a large amount of the input signal into ground. The output signal at this time is thus a small fraction of the full dialed-in voltage. At this time the FET begins a controlled turn-off which increases the output voltage to its full value over the next 100 ms. Then the overall feedback loop adjusts the output voltage to that dialed in on the 745A voltage set dials. This last adjustment is usually only a few percent and is accomplished within a few seconds.

### Calibration Accuracy

The specified voltage accuracy on the 1000 V range for the 745A/746A Calibrator is sufficient to calibrate practically any digital or differential voltmeter presently available. It is possible to enhance the measuring capability of the system by establishing a calibration curve on the 745A/746A itself. This is best accomplished using a thermal converter with a known ac-dc difference for various frequencies, such as one certified by NBS. A set of calibration curves can then be generated for the 745A/746A for each voltage range. Once the calibration curves have been obtained, the long term voltage stability and voltage temperature coefficient characteristics allow the system to furnish highly accurate voltages for extended periods of time.



It is possible to leave the power for the 746A off whenever voltages from 110 V to 1100 V rms are not required. When voltages within this range are needed, the 746A can be energized, and after the 30 second warm-up time these voltages are available within the specified accuracy.

The output current capability of the 746A is rated at 65 mA to supply sufficient current to drive the input capacitance of a voltmeter. A current of 65 mA is sufficient to drive a 100 pF capacitor at 1000 V and 100 kHz. This is also ample to drive several thermal converters in parallel for comparative tests. Because of the output coupling capacitor of the 746A, the output current is derated at the lower end of the frequency band from 63 mA at 200 Hz to 6.3 mA at 20 Hz. The output current at 10 Hz is also rated at 6.3 mA. This is still adequate to drive a 5 mA thermal converter along with a voltmeter whose input resistance is 1 M $\Omega$  or greater. The load regulation is included within the voltage accuracy specifications.

The distortion of the 746A is sufficiently low that the same distortion specification applies to the combination of generator-amplifier as to the generator alone.

### Acknowledgments

It is with great pleasure and appreciation that I acknowledge the group that did the design work on the 746A. Members of this design group were: Chuck Platz, Bill Hale, main amplifier design; Jerry Weibel, logic design; Billy Miracle, Darrell Coble, Dennis Coleman, and Tom Rodine, mechanical design. 

### References

<sup>1</sup> Fred L. Hanson, 'High Accuracy AC Voltage Calibration,' **Hewlett-Packard Journal**, June 1968, p. 2.



#### Fred L. Hanson

Fred Hanson received his Bachelor of Science and Masters degree in Electrical Engineering from Utah State University in 1962 and 1963. He joined Hewlett-Packard in 1963 and worked on the Model 741A AC-DC Differential Voltage/DC Standard. He also worked on development of test equipment for calibration of the ac converter in the Model 741A. This assignment led to development of the Model 745A for which he became design leader. He was group leader for the 746A development. Presently, Fred is product engineering manager for DVM's.

## SPECIFICATIONS (HP MODELS 745A/746A COMBINED) AC Calibrator/High Voltage Amplifier

### RANGES

**OUTPUT VOLTAGE RANGES:** 7 ranges with 10% overrange. Output voltages from 100  $\mu$ V to 110 V are available from 745A output terminals; voltages from 100 V to 1100 V are available from the 746A output cable.

**OUTPUT FREQUENCY RANGES:** continuously adjustable from 10 Hz to 110 kHz in 4 decade ranges with 10% overlap.

**ERROR MEASUREMENT:** 2 ranges with zero center dial;  $\pm 0.3\%$ ,  $\pm 3\%$ . A zero range is provided to easily switch out the effects of the error measurement system.

### PERFORMANCE RATING

**ACCURACY:** accuracy holds for a 90-day period and is met after a 1-hour warmup period at 25°C  $\pm 5^\circ$ C with <95% RH. This applies only to the 745A. 746A warmup time required is approximately 30 s.

**VOLTAGE:** specifications are absolute, traceable to National Bureau of Standards.

1 mV TO 100 V RANGES:

Frequency	Accuracy
50 Hz to 20 kHz	$\pm(0.02\%$ of setting + 0.002% of range + 10 $\mu$ V)
20 Hz to 50 Hz 20 kHz to 110 kHz	$\pm(0.05\%$ of setting + 0.005% of range + 50 $\mu$ V)
10 Hz to 20 Hz	$\pm(0.2\%$ of setting + 0.005% of range + 50 $\mu$ V)

1000 V RANGE:

Frequency	Accuracy
50 Hz to 20 kHz	$\pm 0.04\%$ of setting
20 Hz to 50 Hz 20 kHz to 50 kHz	$\pm 0.08\%$ of setting
50 kHz to 110 kHz	$\pm 0.15\%$ of setting
10 Hz to 20 Hz	$\pm(0.2\%$ of setting + 0.005% of range)

**FREQUENCY:**  $\pm(2\%$  of setting + 0.2% of end scale).

**ERROR MEASUREMENT:**  $\pm(0.5\%$  of setting + 0.5% of range).

### OUTPUT CHARACTERISTICS

**TOTAL DISTORTION AND NOISE:** 0.05% of setting + 10  $\mu$ V over 100 kHz bandwidth on all ranges.

**TOTAL DISTORTION, CYCLE-TO-CYCLE INSTABILITY AND NOISE:** will cause  $< \pm 0.005\%$  of error when used to calibrate an average-responding or true rms-responding instrument from 1 mV to 1100 V.

**LINE REGULATION:**  $\pm 0.001\%$  of setting change in output voltage for a 10% change in line voltage (included in accuracy specs).

**OUTPUT TERMINALS:** high and low output terminals can be floated  $\pm 500$  V dc above chassis ground.

**COUNTER OUTPUT:** frequency counter output on 745A rear panel, 2.2 V  $\pm 20\%$ , protected against short circuits.

### GENERAL

**POWER:**

745A: 115 V or 230 V  $\pm 10\%$ , 50 Hz to 400 Hz, 100 W max.

746A: 115 V or 230 V  $\pm 10\%$ , 50 Hz to 60 Hz, 850 W max.

746A aux power rated at 120 W max.

**WEIGHT:**

745A: net 65 lb (29,3 kg), shipping 80 lb (36,3 kg).

746A: net 75 lb (34 kg), shipping 85 lb (38,5 kg).

**PRICE:** HP 745A, \$4500. HP 746A, \$2000.

**MANUFACTURING DIVISION:** HP LOVELAND DIVISION  
P.O. Box 301  
815 Fourteenth Street S.W.  
Loveland, Colorado 80537

# A New Camera for High-Speed Oscilloscope Recording

By Dan Paxton

AN EVENT OCCURS JUST ONCE, and it deflects an electron beam that is moving across a phosphor surface at one-tenth the speed of light—just once.

An oscilloscope camera has to capture and preserve this event. Whether or not the camera can capture a fleeting trace, one that may be too faint to be seen by the eye, depends on several factors.

Most important is the lens, as it determines the amount of light reaching the film, and how sharply the light is focused. Then there is the image size, as it determines how much the available light is concentrated for heightened contrast. That the type of film used affects writing speed goes without saying.

A new Oscilloscope Camera, Hewlett-Packard Model 195A, has been designed to optimize these factors for maximum trace writing speed. It uses an 8-element, 80 mm, f/1.3 lens made exclusively for this camera by the Ilex Optical Company. The lens is set up to give a half-

size image, an optimum compromise between writing speed and easy visual interpretation. The combination of the f/1.3 lens and the 1:0.5 object-to-image ratio obtains a 3 to 1 improvement in oscilloscope photographic writing speed over that of a standard camera using an f/1.9 lens and a 1:1 object-to-image ratio.

## Maximizing Writing Rate

Maximum use of the Camera's capabilities can be made with the 183A Oscilloscope. The flood gun in that instrument's cathode-ray tube provides a uniform background illumination for 'pre-' or 'post-fogging' the film.\* This enhances apparent sensitivity by raising the exposure level to the region of the film's maximum contrast thus requiring less light in the trace to make the trace visible (Fig. 2). The flood gun can be set to flash automatically *after* the event occurs, a technique that

\* See "A DC-to-VHF Oscilloscope" by James Pettit, *Hewlett-Packard Journal*, Vol. 21, No. 5, January 1970.

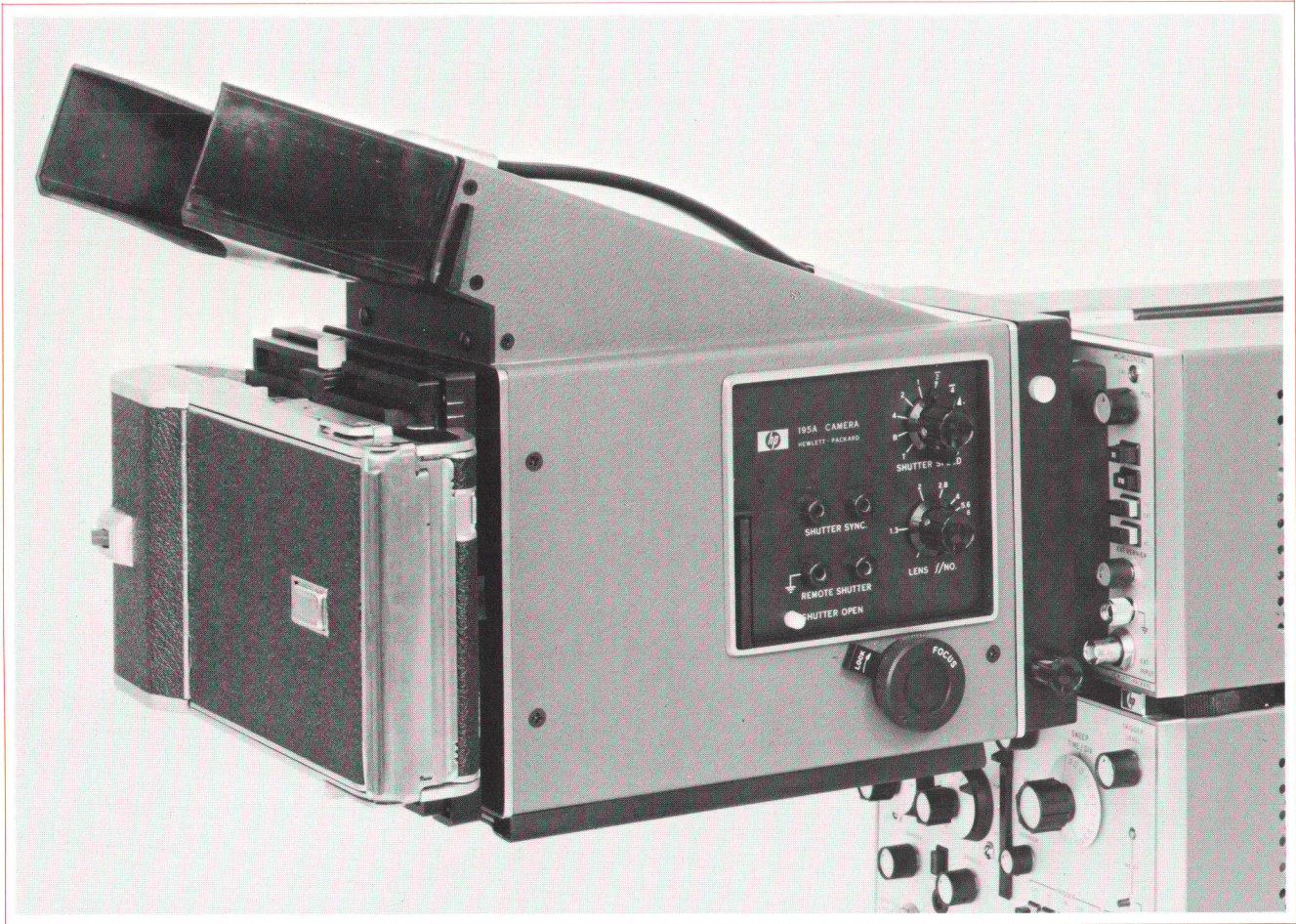
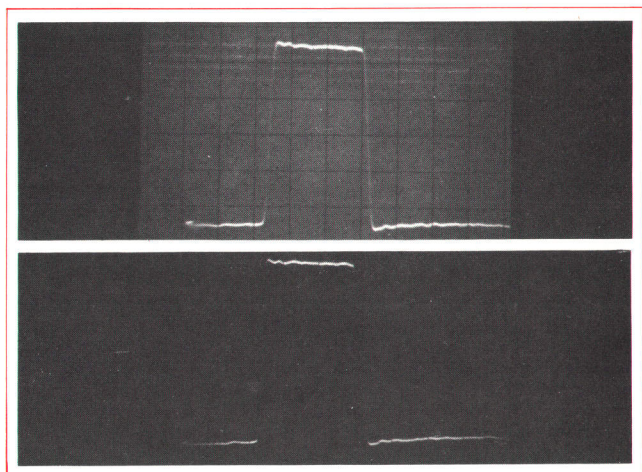

**Fig. 1.** Hewlett-Packard Model 195A Oscilloscope Camera mounts directly to HP 5-inch round and rectangular CRT bezels. Adapters, optionally available, fit Camera to most oscilloscopes of other manufacturers.

has been found to increase apparent speed of the film  $1\frac{1}{2}$  to 2 times.

If the new Camera is to be used with oscilloscopes that do not have flood gun illumination, it may be equipped with an ultraviolet lamp that achieves the same effect by fluorescing the phosphor.

Although optimized for high-speed photography, the Camera is equipped for general purpose applications. Controls are easily accessible on the outside of the Camera housing. The shutter is controlled electronically, and it makes accurate exposures at all shutter speeds, which range from  $1/30$  to 4 seconds. The shutter can be tripped manually, or tripped electrically by an external contact to ground. The shutter itself closes a contact for operating external equipment. The shutter also has bulb and time modes. An indicator lamp shows when the shutter is open, an especially useful feature for single-shot photography as it confirms that the camera is ready for signal display.



**Fig. 2.** Trace writing speed is increased by film and phosphor 'fogging' (upper trace) over speed obtained without fogging (lower trace), as shown by leading and trailing edges of fast pulse ( $t_r = 1.5$  ns). Internal flood gun in Model 183A Oscilloscope fogs film and phosphor automatically in synchronism with horizontal sweep.

The Camera normally is supplied with a film holder for Polaroid® roll film but if the extreme sensitivity of the Polaroid ASA 10,000 speed roll film is not required the Camera can be equipped with a Polaroid Flat Pack film holder or a Graflok® 4 x 5 film holder (camera backs are interchangeable). The Camera backs can be rotated in 90° increments, and moved linearly through 11 detented vertical positions to allow flexibility in placing several exposures on one sheet of film. 

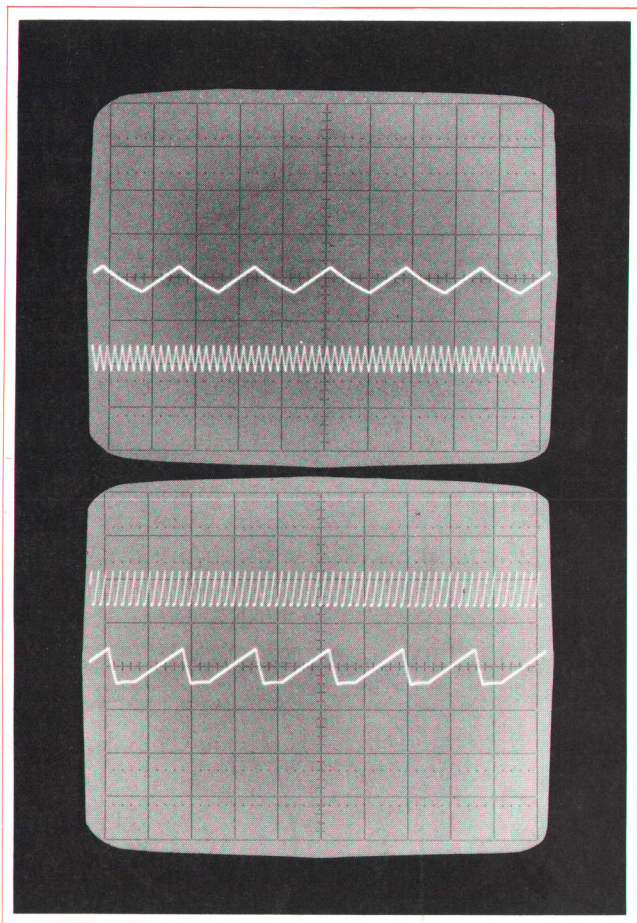

Fig. 3. Movable film holder and half-size image allow placement of two photos on one sheet of film.

## SPECIFICATIONS

### HP Model 195A Oscilloscope Camera

**OBJECT-TO-IMAGE RATIO:** 1:0.5.

**LENS:** 80 mm. f/1.3 high transmission lens; aperture ranges from f/1.3 to f/11.

**SHUTTER:** Electronically operated and timed shutter, with all solid-state circuits; shutter speeds are  $\frac{1}{50}$ ,  $\frac{1}{15}$ ,  $\frac{1}{8}$ ,  $\frac{1}{4}$ ,  $\frac{1}{2}$ , 1, 2, 4 seconds, Time, and Bulb; shutter has sync contact closure output for triggering external equipment and input jack for remote shutter operation.

**SHUTTER-OPEN LIGHT:** Provides visual indication of open shutter

**CAMERA BACK:** Polaroid® roll film holder standard; Polaroid® pack film holder or Graflok® backs available in place of roll film holder at no extra cost. Backs may be interchanged without refocusing, and may be rotated in 90-degree increments.

**MOUNTING:** Quick lift on-off mounting with positive lock; swing away to left. Adapters (\$15) allow 195A to be used with almost all other manufacturers' oscilloscopes.

**VIEWING:** Low-angle, direct viewing, flexible face-mask; hood may be replaced with Model 10354A Viewing Hood Replacement Plate (\$7) to allow stacking on 7-inch high oscilloscopes.

**MULTIPLE EXPOSURE:** Back moves vertically through 11 detented positions.

**FOCUS:** Adjustable focusing with lock; combination split image focusing plate and reduction ratio scale provided.

**DIMENSIONS:** 14½ in. long, 9¾ in. wide, 10½ in. high (368 x 248 x 172 mm) without hood.

**WEIGHT:** Net, 12 lb (5,4 kg). Shipping, 18 lb (8,2 kg).

**POWER:** 115 V ±10%, 50 to 400 Hz, 6 watts.

**PRICE:** \$975.

**MANUFACTURING DIVISION** HP Colorado Springs Division  
1900 Garden of the Gods Road  
Colorado Springs, Colorado 80907

### Dan Paxton

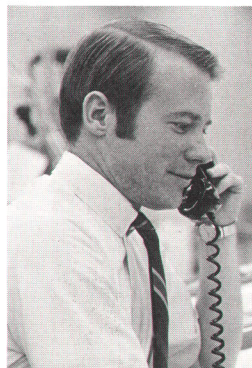

What can a mechanical engineer do at Hewlett-Packard? Plenty. In Dan Paxton's case, it's design of scope accessories, like probes, tripods, and now, cameras. Dan earned his BSME from the California Institute of Technology in 1964 and his MSME a year later. He joined HP that same year.

Dan has been flying for fun for the past three years, also likes skiing, target pistol-shooting, and making photographic portraits of Colorado wildflowers.

## HEWLETT-PACKARD JOURNAL APRIL 1970 Volume 21 • Number 8

TECHNICAL INFORMATION FROM THE LABORATORIES OF THE HEWLETT-PACKARD COMPANY PUBLISHED AT 1501 PAGE MILL ROAD, PALO ALTO, CALIFORNIA 94304  
Editor: R. H. Snyder Editorial Board: R. P. Dolan, H. L. Roberts, L. D. Shergalis Art Director: Arvid A. Danielson Assistant: Maridel Jordan